

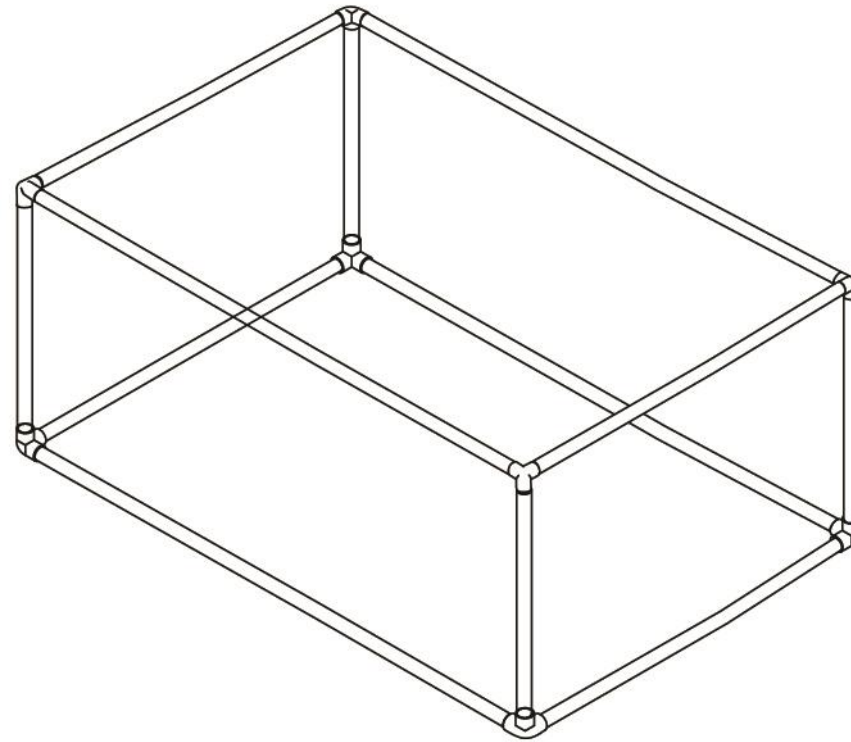

**KLEVERCAGES**<sup>TM</sup>  
PVC CONNECTOR SPECIALISTS



# **Small Klever Cage kit**

## **ASSEMBLY INSTRUCTIONS**

# Parts included in kit

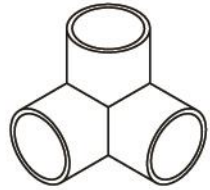

20mm 3-Way  
Elbow Connector  
Qty: (8)

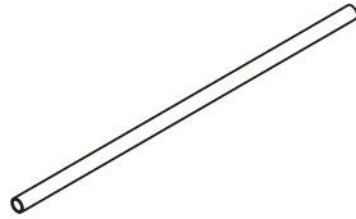

20mm PVC Pipe-860mm  
Qty: (4)



20mm PVC Pipe-440mm  
Qty: (4)



20mm PVC Pipe-380mm  
Qty: (4)



Netting  
(pre-sewn rectangle fine  
mesh)  
Qty: (1)

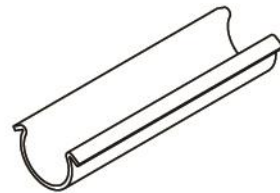

20mm Snap Clamp  
Qty: (10)



## Step 1: Assemble base -1st part

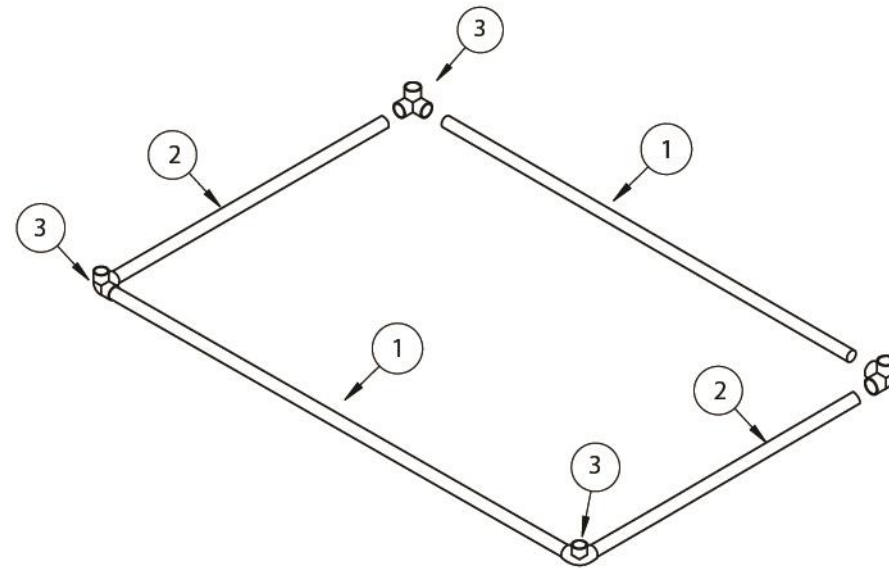
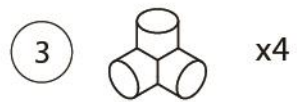
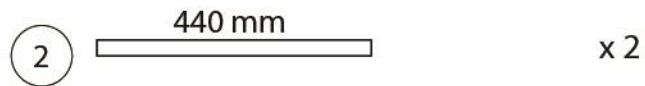
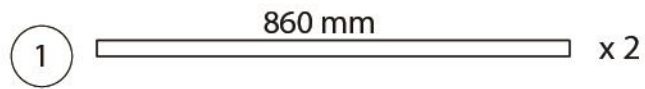

## Step 2: Add verticle pipes

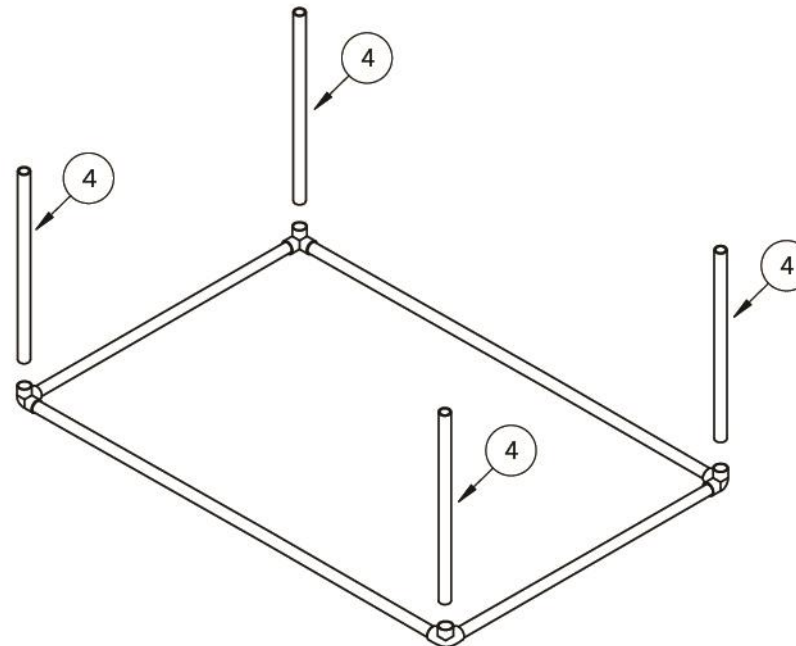
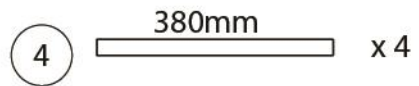

# Step 3: Assemble Top part

1 860 mm x 2

2 440 mm x 2

3 x4

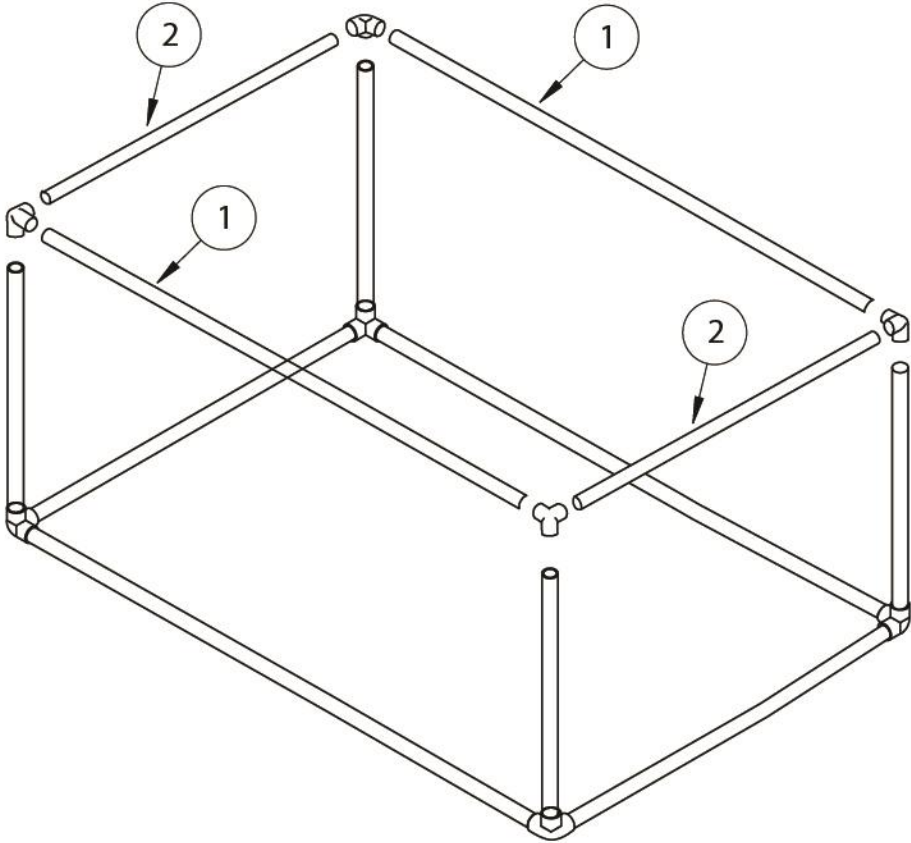

## Step 4: Netting

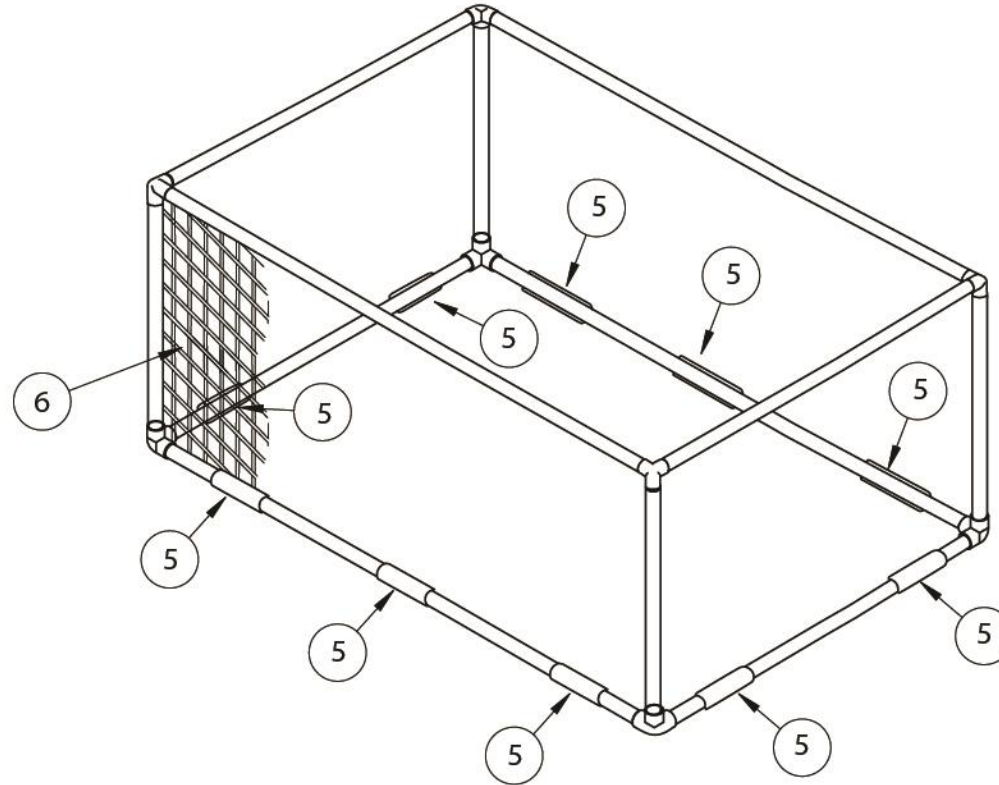
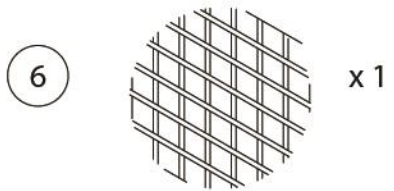

## Step 5: Finishing

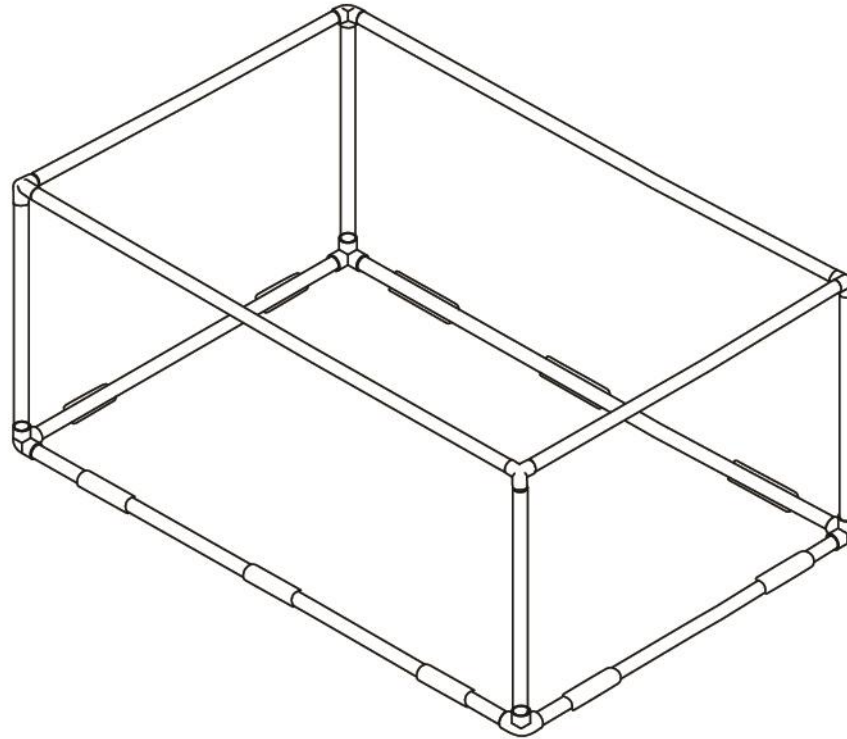

NOTE!

Join us on Facebook for project plans, netting options, updates, and much more!  
[www.facebook.com/klevercages](http://www.facebook.com/klevercages)  
or visit us on the web at  
[www.klevercages.com.au](http://www.klevercages.com.au)

---

Telephone: 04319-CAGES  
Website: [www.klevercages.com.au](http://www.klevercages.com.au)



KleverCages © 2017